



## LOCALIZED SHUTDOWN SYSTEMS

### FK-5-1-12

#### MARE-FK SERIES

Suitable on class fires



They are systems made and designed to be installed on board of pleasure boats, length no more than 24 meters, for the purpose of protecting the engine compartments.

The system can be installed both internally and externally to the engine compartment and connected with optional aluminium tube for discharge at a predetermined point.

The valve equipped with a thermoexpanding bulb allows the activation of device when the set temperature is reach (standard bulb at 93°C).

The valve is also equipped with a pressure switch for constant signalling of the pressure inside the device. On the valve is possible the installation of pyrotechnic cartridge for a remote activation.



INCLUDED ACCESSORIES

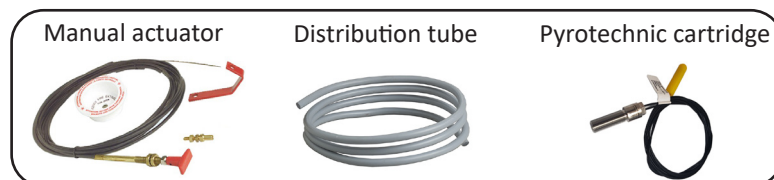

OPTIONAL ACCESSORIES

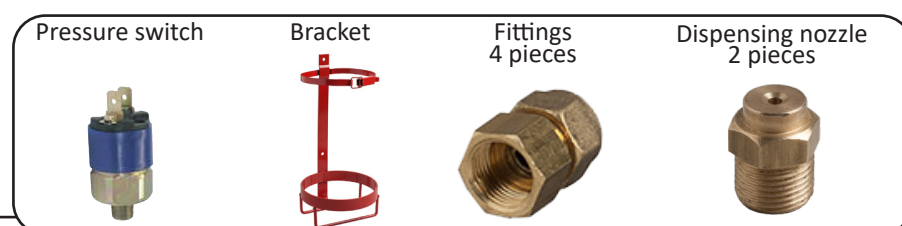

REPRODUCTION IS PROHIBITED

File name	Type of document	Fire Extinguisher Model	Date	Rel.	Check	Rev.	Pag.
mare FK series	technical manual	localized shutdown	14/02/2024	M.R		2	1/5

## TECHNICAL SPECIFICATIONS

CYLINDER	In high-strength alloy steel, external powder painting Red Ral 3000
EXTINGUISHING AGENT	Clean Agent FK-5-1-12
PROPELLANT	Nitrogen (N <sub>2</sub> )
VALVE	M. 30x1.5, with bulb in standard equipment, supplied with pressure switch set at 11 bar
USE	A B fire rating (solid materials, flammable liquids)
ACTIVATION	Automatic when bulb temperature is reached; On request (see optional): - with manual actuator with handle, - with pyrotechnic cartridge for electric activation.  *Note: the valve allow installation of both of two optional activation, is possible to install both at the same time
BULB TEMPERATURE ACTIVATION	93°C
SYSTEM TEMPERATURE RANGE	-20°C/+60°C
SYSTEM PRESSURE	15 bar at 20°C
BRACKET	Wall-mounted in standard equipment, iron painted

## AVAILABLE MODELS

System Code	Max covered Volume (m <sup>3</sup> )	Cylinder Volume (L)	Nominal charge (Kg)	Max tube length (m)	Cylinder diameter (mm)	Max dimensions L x H (mm)	* Weight (Kg)
11509-015	1,5	1,25	0,80	2	85	120 x 350	~ 2,55
11509-030	3,0	1,25	1,60	2	85	120 x 350	~ 3,35
11509-050	5,0	2,50	2,70	2	110	130 x 400	~ 5,10
11509-075	7,5	4,30	4,00	2	130	145 x 455	~ 7,20
11509-085	8,5	4,30	4,50	3	130	145 x 455	~ 7,70
11509-100	10,0	4,30	5,30	3	130	145 x 455	~ 8,50
11509-125	12,5	7,30	6,60	3	160	180 x 500	~ 11,15
11509-150	15,0	7,30	7,90	4	160	180 x 500	~ 12,45
11509-180	18,0	7,30	9,50	5	160	180 x 500	~ 14,05
11509-200	20,0	10,70	10,50	6	170	190 x 620	~ 16,20

\*Weight includes: pressure switch, bracket, 2 dispensing nozzles, 4 fittings

## TECHNICAL SPECIFICATIONS FOR OPTIONAL PARTS



Code 1890-3      Manual actuator kit for remote activation, including:  
 - stainless steel cable 6 m, plastic coated, with brass terminals.  
 With special self-tapping terminals that allow to cut cable at right measure and then install into terminals;  
 - cable storage box, ABS white.



Code 2164 (quantity for meters)  
 Distribution tube for extinguishing agent, in aluminum with PVC external coating , 10 mm diameter.



Code 2166-1  
 Pyrotechnic cartridge for remote electric activation.

File name	Type of document	Fire Extinguisher Model	Date	Rele.	Check	Rev.	Pag.
mare FK series	technical manual	localized shutdown	14/02/2024	M.R		2	2/5

## SPARE PARTS



N.	DESCRIPTION	CODE	
1	M. 30x1.5 valve with thermosensible bulb for automatic activation 93°C	1906	
2	Pressure gauge 1/8 NPT	0272	
3	Cylinder	1,25 L	0101
		2,50 L	0102
		4,30 L	0103
		7,30 L	1848K
		10,70 L	0105-7
4	Bracket	1,25 L	0326
		2,50 L	0327
		4,30 L	0315-1
		7,30 L	0316-1
		10,70 L	0318-2
5	Label for cylinders up to 2,50 L	2064-51	
	Label for cylinders 4,30 L	2064-52	
	Label for cylinders 7,30 L and upper	2064-5	
6	Pressure switch 1/8" , set at 11 bar, with protection cap	1161	
7	PVC dip tube	1,25 L	0151
		2,50 L	0152
		4,30 L	0153
		7,30 L	1859
		10,70 L	0155-1
8	Dispensing nozzle M 3/8"	2163	
9	Distribution tube for ext. agent - meters q.ty	2164	
10	Fitting for distribution tube, F 3/8" ogive	2165	
11	Manual actuator kit for remote activation	1890-3	

### IDEAL INSTALLATION ILLUSTRATION

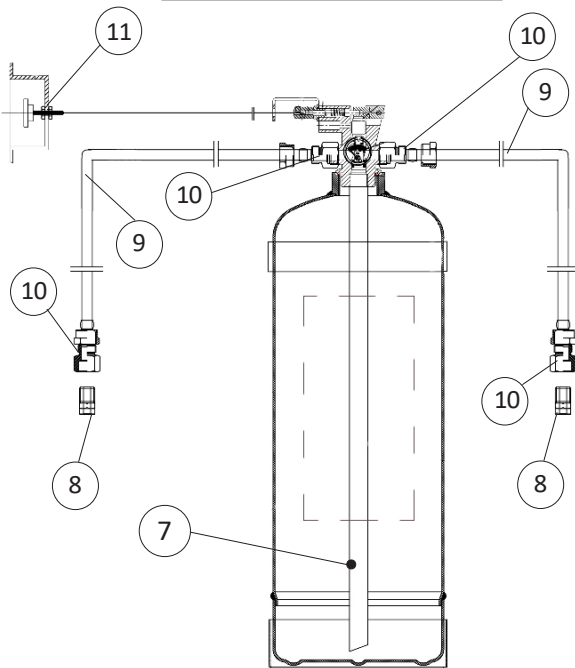

### REFERENCE FOR CYLINDERS 7,30 L AND UPPER

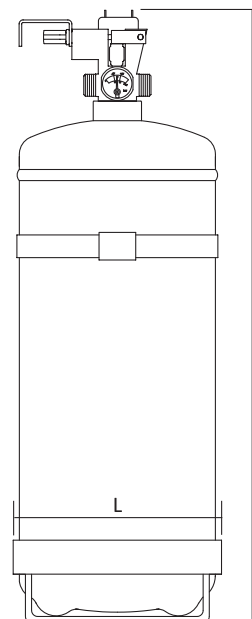

### REFERENCE FOR CYLINDERS 1,25 L - 2,50 L - 4,30 L

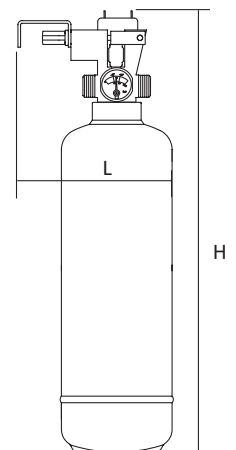

REPRODUCTION IS PROHIBITED

File name	Type of document	Fire Extinguisher Model	Date	Rel.	Check	Rev.	Pag.
mare FK series	technical manual	localized shutdown	14/02/2024	M.R		2	3/5

## Warnings for use

- 1) Suitable for use on electrical fires (control panels or electrical circuits).
- 2) Ventilate the room after use.
- 3) Recharge the device after each use, even if partial

## Maintenance and periodic controls

Maintenance and installation operations must be carried out by personnel specialized in the use of pressure equipment and as reported in this technical manual.

During maintenance it is necessary to take all precautions to prevent fires, make the device safe by repositioning the safety plug and operate in a sufficiently open and ventilated room.

Maintenance must be carried out with the frequency indicated by the country in which it is installed, in Italy it must be carried out in accordance with the "safety of navigation" circular general series no. 100/2014.

The use of non-original spare parts, or those not authorized by the manufacturer Emme Antincendio srl, will invalidate the approval of the systems covered by this technical manual.

\*Note : Check and comply with the dispositions in force in the country of destination and use of the system.

The date for the audit activity must always be calculated from the production date indicated in the declaration of conformity. The date for the hydrotest must always be calculated from the date marked on the tank.

Maintenance includes the following activities recommended by the manufacturer

STEP	PERIODICITY	OPERATIONS
User supervision	Recommended every month by qualified on-board staff or user	Check that pressure gauge indicator is inside green area, so that there are no air leaks
Inspections and Maintenance	Every year inspection, carried out by qualified on-board personnel or an authorized company	Visually check that all accessible components are in working order. Examine all extinguishing agents containers externally, to ensure the absence of damage or corrosion. Check the hydrostatic test date of the cylinder storage and the date of verification of the quantity of extinguishing agent. Perform the functional test of the optical and audible alarms, if present. Check the correct operating position of the control valve. Check the dispensing tube, make sure that no damages or corrosion signs are presents
	Every 5 years inspection, carried out by qualified on-board personnel or an authorized company	Change the extinguishing agent, check inside conditions of cylinder, check condition and functioning of valve and of others components (o-ring, stem of valve, ecc.)
Hydrotest Cylinder	Every 10 years inspection, carried out by authorized company	Check of mechanical stability of cylinder with hydrotest of cylinder at pressure test marked on cylinder identified with "PT" Change the dispensing tube

## Product Warranty

Any restoration operations and instrumental checks must be carried out exclusively by competent and authorized personnel, with the documentation necessary to carry out the operations to maintain product performance. Any tampering or intervention by unauthorized personnel will void the product warranty.

## End-of-life

The disposing of the devices must be carried out by qualified personnel and in conformity at European Directives and National Rules regarding safety and environmental protection.

The risk deriving from incorrect handling during decommissioning is mainly linked to external impacts.

File name	Type of document	Fire Extinguisher Model	Date	Rele.	Check	Rev.	Pag.
mare FK series	technical manual	localized shutdown	14/02/2024	M.R		2	4/5

## Installation

The installation must be carried out by qualified personnel who are aware of the risks of pressurized equipment and the precautionary measures that must be taken to avoid them.

The system components are designed to be installed on supports supplied and fixed to the structure of the boat in order to resist shock and vibration movements during operation.

The cylinders containing the extinguishing agent and the activation control are not subject to temperatures outside the designated operating range of the system.

The extinguishing system must be installed with an adequate discharge pre-alarm system (discharge delay) as required by ISO 9094:2015 pt. 7.6.3.3. The pre-alarm system must be designed and installed by installer and are not provided by manufacturer of system.

The cylinders with extinguishing agent can be installed both inside or outside the protected room.

Place the device in the supplied bracket, in vertical position and with valve looking up for MARE-FK model.

Installation in places of passage must be carried out in such a way as to avoid the possibility of accidental impacts.

- 1) Install the fire prevention system inside or outside the engine compartment, with the appropriate supplied bracket.
- 2) Check that pressure gauge indicator is inside green area.
- 3) Place the dispensing tube (pos.3) and fix nozzles (pos.1) at edge with supplied fittings. Place nozzles in vertical position and looking down, in the area of higher fire risk of the engine.
- 4) If manual actuator is present (optional) proceed with installation. Place the cable (pos.4) and fix into the box (pos.2). Put the cable (pos.4) into the pawl (pos.7) and screw the allen key.
- 5) Connect the pressure switch to the visual system located on the dashboard or anyway in a visible position.
- 6) If pyrotechnic cartridge is present (optional) proceed with installation. Screw in specific seat (pos.6) and connect to a button or electrical control unit with 12 V 0,5 Ah
- 7) Remove safety pin (pos.5).

The system is operative

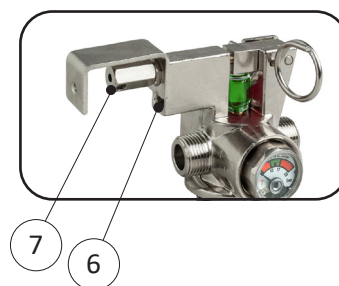
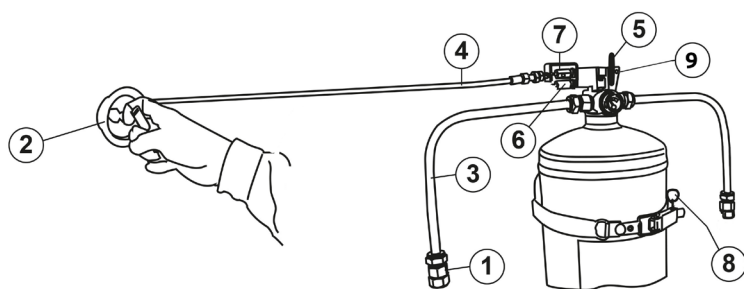

### LEGEND

- 1) Dispensing nozzle
- 2) Remote manual actuator
- 3) Dispensing pipe
- 4) Cable of manual actuator
- 5) Safety pin
- 6) Seat for optional activation commands
- 7) Pawl for connection of manual actuator cable
- 8) Bracket

File name	Type of document	Fire Extinguisher Model	Date	Rele.	Check	Rev.	Pag.
mare FK series	technical manual	localized shutdown	14/02/2024	M.R		2	5/5