

Use and Maintenance Technical Manual



www.emme-italia.com

Via del Molino, 40 - 52010 Corsalone (AR) - Italy - info@emme-italia.com - Tel. +39.0575.511320
 Other branches Emme Antincendio s.r.l. in Italy : Milano - Padova - Roma - P.IVA/ C.F. 11208251006 - R.E.A. AR-159122

22031-1 : Portable Fire Extinguisher, 3 L Foam



CLIP DETAIL



- **CYLINDER**
Stainless steel, 3 pieces drawing, with clip, external powder painting Red Ral 3000.
- **EXTINGUISHING AGENT**
Water-based foam.
- **PROPELLANT**
Dehumidified air or nitrogen (N₂).
- **VALVE**
M. 58x2, lightweight aluminum alloy AA6061 body, with external device for pressure check, levers with black painting.
- **USE**
A B F fire rating (solid materials, flammable liquids, cooking oils).

© REPRODUCTION IS PROHIBITED

Note: image is for illustrative purpose only, the product purchased can has some difference

3 L foam fire extinguisher, temperature range from 0°C to +60°C, manufactured in accordance to **UNI EN 3-7 (D.M. 7.1.2005)**, approved Marine Equipment Directive **MED 2014/90/EU**, certified according to the directive for pressure equipment PED 2014/68/EU. Manufactured according at productions checks as agreed with **EN 3-10**. Quality Product certification guaranteed by Bureau Veritas Italia. Suitable for use on fire involving electrical voltages up to 1'000 V, at a distance of 1 meter.

APPROVED/CERTIFIED FIRE EXTINGUISHER:



FIRE RATING :



File name	Type of document	Fire Extinguisher Model	Date	Rel.	Check	Rev.	Pag.
22031-1_Technical manual	Use and Maintenance technical manual	22031-1	15/01/2024	M.R		1	1/8

22031-1 : Portable Fire Extinguisher, 3 L Foam

TECHNICAL SPECIFICATIONS

FIRE RATING	13 A 113 B 40 F
EXTINGUISHING AGENT	Foam EWAB15 (2 % SC-6 + 12 % Inilam AX + 86 % Water)
PROPELLANT	Dehumidified air or Nitrogen (N ₂), 15 bar at 20°C
TEMPERATURE RANGE	0°C / +60°C
NOMINAL CHARGE	3 Liters
FULL WEIGHT	~ 4,8 Kg
DIMENSIONS	Height (base - valve) 445 +/- 5 mm Diameter (cylinder) 130 +/- 2 mm
DISCHARGE TIME	~ 18,8 seconds
VALVE TIGHTENING TORQUE	Minimum 40 Nm, Maximum 60 Nm
CYLINDER PRESSURE TEST	PT 27 bar
CYLINDER VOLUME	3,9 L.
SAFETY DEVICE	Set between 22 and 27 bar
CYLINDER MATERIAL	Stainless steel
EXTERNAL /INTERNAL TREATMENT	Sandblast and powder painting, Red Ral 3000 colour

PACKAGING

(Note: the packaging quantities and measurements are indicative and can be subject at changes)

STANDARD

Maximum nr. 126 pieces for pallet
(63 pieces for box, max 2 boxes for pallet)
(12 pieces. single packaging)
Pallet dimensions 100x120x115(h) cm

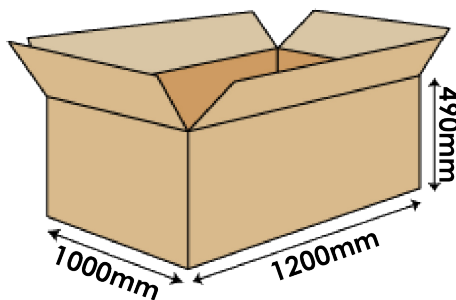

ON REQUEST: SINGLE PACKAGING

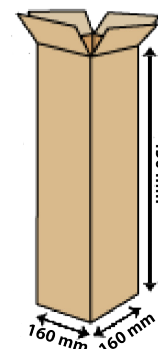

TRANSPORT DISPOSAL

Land transport : Exemption for the purposes of ADR disposal 594

Ship Transport : IMDG Code - UN 1044 class 2.2 Fire Extinguishers

File name	Type of document	Fire Extinguisher Model	Date	Rele.	Check	Rev.	Pag.
22031-1_Technical manual	Use and Maintenance technical manual	22031-1	15/01/2024	M.R		1	2/8

22031-1 : Portable Fire Extinguisher, 3 L Foam

COMPONENTS AND SPARE PARTS LIST

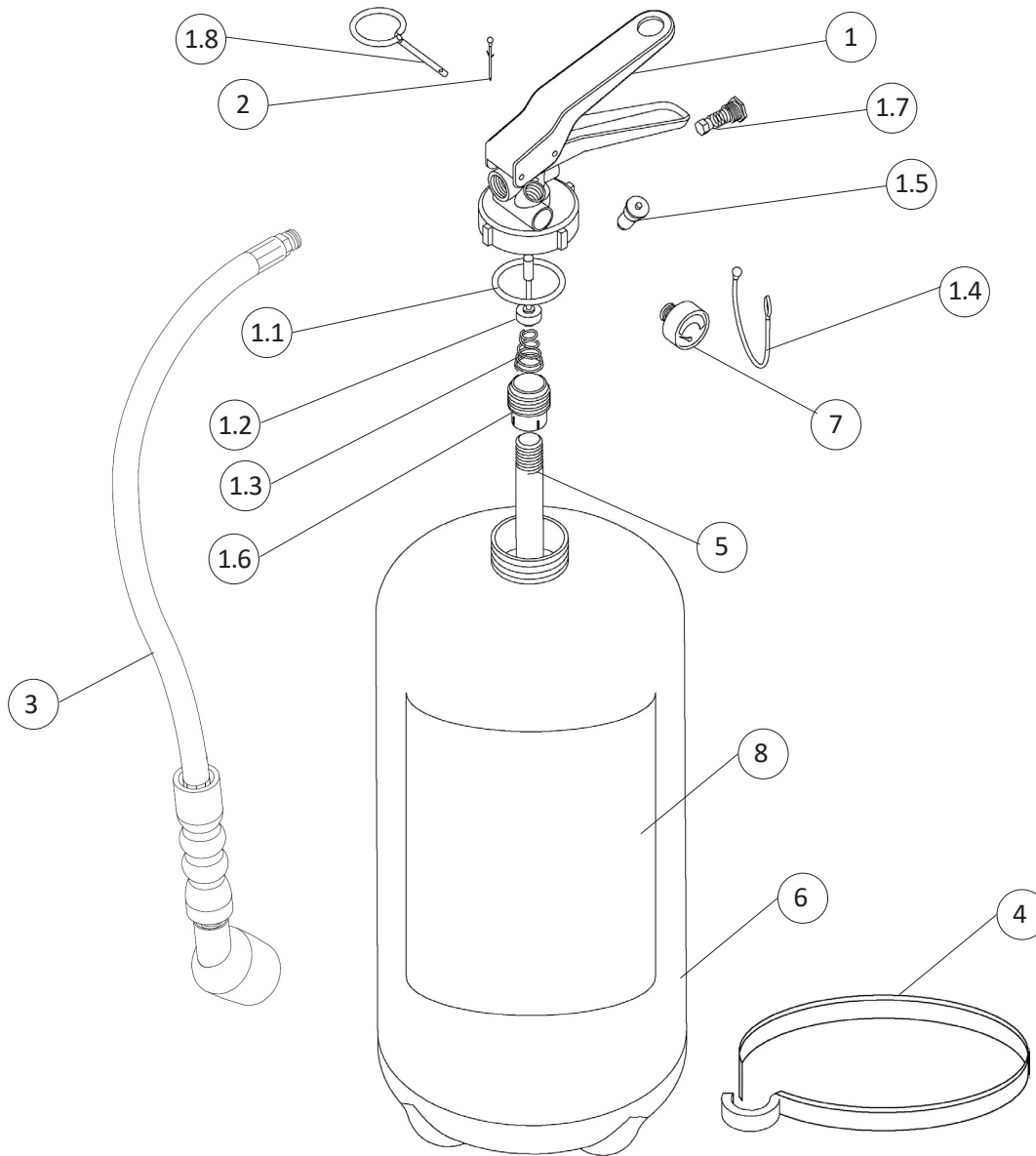

Table 1

NUM.	DESCRIPTION	CODE	NUM.	DESCRIPTION	CODE
1	Valve M. 58x2	0212-5	4	Stop-hose band	1907-3
1.1	O-ring valve	0201-4	5	PVC dip tube	0152
1.2	Valve stem	n.a.	6	Cylinder	1583-1
1.3	Internal spring of the valve	n.a.	7	Pressure gauge	1576
1.4	Temper seal (black)	0286N	8	Label	1585-1
1.5	Test valve for pressure gauge	1163	OPTIONAL	Iron marine bracket red painting	0315
1.6	Dip tube holder	n.a.	OPTIONAL	Wall-mounted bracket for fire extinguisher with clip	3036
1.7	Safety device	n.a.		Foam refill (3 L. bottle, ready to use)	2054-2
1.8	Safety pin	0282-1			
2	Safety pin seal (green)	0285			
3	Hose with dispensing nozzle	2209-1			

The spare part at number 1 includes already all others components indicated from 1.1 to 1.8
 "n.a." mean that the component is not available as single spare part

File name	Type of document	Fire Extinguisher Model	Date	Rele.	Check	Rev.	Pag.
22031-1_Technical manual	Use and Maintenance technical manual	22031-1	15/01/2024	M.R		0	3/8

22031-1 : Portable Fire Extinguisher, 3 L Foam

Maintenance periods for efficiency guarantee, methods and subjects accredited for maintenance

1) GENERAL REQUIREMENTS

All Fire Fighting Fire Extinguishers produced by Emme Antincendio must be installed, inspected and maintained in accordance with the following manual and with the rules in force in the country of destination.

All fire extinguishers must be recharged after partial use with original spare parts.

Every ordinary / extraordinary maintenance operation must be carried out using original spare parts and compliant with the declared certified prototype. The described below maintenance operations must be carried out by recognized personnel qualified by the company Emme Antincendio.

Fire extinguishers are classified into two categories that provide for specific construction standards:

- portable fire extinguishers: fire extinguishers designed to be transported and operated by hand, with a mass not exceeding 20 kg under operating conditions. Reference standard: EN 3-7
- wheeled fire extinguishers: wheel fire extinguishers designed to be transported and operated by hand, with a mass greater than 20 kg. Reference standards: EN 1866-1

Moreover, in relation to the extinguishing agent contained in them, they are identified in:

- water based fire extinguishers including foam extinguishers;
- powder fire extinguishers;
- carbon dioxide fire extinguishers;
- clean agent extinguishers

2) REFERENCE RULES

Fire Extinguishers produced by Emme Antincendio are manufactured in compliance with the following rules:

- EN 3-7: 2008 Portable fire extinguishers;
- EN 1866-1: 2008 Wheeled fire extinguishers;
- PED Directive 2014/68/EU pressure equipment;
- MED Directive 2014/90/EU devices for marine use (only for products bearing the relative MED certification mark, see pag 1 of this document)

3) INSTALLATION

- 1) Install the fire extinguisher with the appropriate bracket, with the handle at a maximum recommended height of 110 cm.
- 2) When installed in a vehicle the fire extinguisher must be held in a specific truck bracket.
- 3) Do not expose the fire extinguisher to the atmospheric agents or chemicals agents.
(Note: in these cases protect the fire extinguisher with a special cabinet or protective cover.)
- 4) Do not expose the fire extinguisher to the direct sunlight.
- 5) Verify that the gauge pressure indicator is inside the green area.
- 6) Keep children away from fire extinguisher.
- 7) For Marine equipment or outdoor installation we recommend use of cover or cabinet.

4) MODALITY AND PRECAUTIONS FOR THE USE

- 1) Follow the operating Instructions printed on the main fire extinguisher label

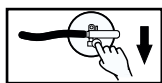

1) REMOVE SAFETY PIN



2) HOLD THE HOSE



3) SQUEEZE GRIP LEVER



4) AIM THE JET AT BASE OF FIRE

- 2) Do not through the fire extinguisher on to the direct flames.
- 3) This fire extinguisher is a pressurized vessel and must not be pierced, dented or subjected to external damage.
- 4) Do not direct the jet on the people.

File name	Type of document	Fire Extinguisher Model	Date	Rele.	Check	Rev.	Pag.
22031-1_Technical manual	Use and Maintenance technical manual	22031-1	15/01/2024	M.R		0	4/8

22031-1 : Portable Fire Extinguisher, 3 L Foam

5) STEPS AND FREQUENCY RELATED TO MAINTENANCE OPERATIONS

(For stored pressure fire extinguishers)

Note: The user have to complies to the national or international rules, if they are more restrictive of the below table

Table 2

Ref.	Periodicity	Step	Operations
5.1	12 Months	Ispection	Check internal pressure using an independent tool
5.2	5 Years	Maintenance	Replace the extinguishing agent. Check the thread of the valve body and if a non-compliance is detected, replace it.
5.3	10 Years	Hydrotest Cylinder	Check the conservation status and perform the hydraulic test of the cylinder with suitable tool.
5.4	*20 Years		Is recommended the replacement of the fire extinguisher

* If it located in particular environments the timing can be reduced.

(it is recommended to reduce to 10 years)

N.B. : All the operations must be calculated from the date of placing on the market.

For the hydraulic test refer to the date stamped on the tank.

5.1) Inspection Steps

1	Remove the fire extinguisher from the bracket and check the fixing stability
2	Check the internal pressure with an independent tool
3	Check the safety seal and the safety pin
4	Remove the hose and check the correct internal passage with compressed air
5	Record the inspection activity on the maintenance tag and on the fire protection register

5.2) Maintenance Steps

1	Remove the extinguisher from the support and check the condition of the fastening support Check the condition of the marking label, replace if necessary.	
2	Discharge the fire extinguisher, comply at rules for a correct disposal	
3	Screw off and extract the dispensing valve	
4	Check internally the cylinder and make sure that are no signs of corrosion. For the hose, check the internal passage with compressed air.	
5	Recharge the fire extinguisher with new extinguishing agent	
6	Dispensing valve with aluminum body	Check the thread of valve body and if damaged replace with a new valve. Screw back the valve with a tightening torque of :min. 40 Nm - max. 60 Nm
7	Pressurize the extinguisher(15 bar 20 °C) with dehumidified air or nitrogen and check if there are losses.	
8	Reinsert the safety pin and its relative seal, screw the dispensing hose back on.	
9	Record the activity in the maintenance tag and in the maintenance register.	

File name	Type of document	Fire Extinguisher Model	Date	Rele.	Check	Rev.	Pag.
22031-1_Technical manual	Use and Maintenance technical manual	22031-1	15/01/2024	M.R		0	5/8

22031-1 : Portable Fire Extinguisher, 3 L Foam

5.3) Hydraulic test step













At least every 10 years from the production date the fire extinguisher must be overhauled by a hydraulic pressure test in accordance with the pressure values "PT" stamped on the cylinder.

1	Remove the extinguisher from the support and check the condition of the fastening support Check the condition of the marking label, replace if necessary.	
2	Discharge the fire extinguisher, comply at rules for a correct disposal	
3	Screw off and extract the dispensing valve	
4	Check internally the cylinder and make sure that are no signs of corrosion. For the hoses, check the internal passage with compressed air.	
5	Hydraulic test with special machinery: keep the hydraulic pressure at the "PT" value for 30 seconds and proceed with debrusserization. Check the cylinder general condition.	
6	Proceed with rinsing/removal of any residuals.	
7	Recharge the fire extinguisher with new extinguishing agent	
8	Dispensing valve with aluminum body	Is recommended to replace the dispensing valve with a new one Screw back the valve with a tightening torque of : min. 40 Nm - max. 60 Nm
9	Pressurize the extinguisher(15 bar 20 °C) with dehumidified air or nitrogen and check if there are losses.	
10	Reinsert the safety pin and its relative seal, screw the dispensing hose back on.	
11	Record the activity in the maintenance tag and in the maintenance register.	

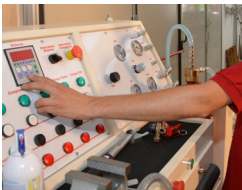
File name	Type of document	Fire Extinguisher Model	Date	Rele.	Check	Rev.	Pag.
22031-1_Technical manual	Use and Maintenance technical manual	22031-1	15/01/2024	M.R		0	6/8

22031-1 : Portable Fire Extinguisher, 3 L Foam

Executive details Inspection steps, Maintenance, Hydraulic test

	<p>1 - Remove the fire extinguisher from the bracket; check marking label and replace it if damaged, check stability of the bracket, cleaning, general conditions</p>	<p>2 - Unload completely the fire extinguisher , comply at local rules for the correct disposal.</p>
 	<p>3 - Screw off and remove the valve.</p>	<p>4 - Check the inside of the tank with the appropriate inspection lamp. Also check that the hose is not obstructed, checking the correct passage of compressed air inside it, if necessary replace it with a new one.</p>  
	<p>5 - Hydraulic cylinder test: maintain hydraulic pressure at "PT" for 30 seconds and proceed with depressurization</p>	<p>6 - Proceed to rising/ removal of any residues</p>
	<p>7 - Recharge the fire extinguisher with extinguishing agent</p>	<p>8 - Screw the dip tube and the dispensing valve back on. Perform the operation with a suitable torque wrench. Making sure you have set the correct one tightening torque</p> 
 	<p>9 - Pressurize the extinguisher with pliers, check that there are no pressure losses, using the appropriate leak detector. Reinstall the safety pin and relative seal</p>	<p>10 - Screw the hose. Check the correct reading of the pressure control manometer</p> 
	<p>11 - Record the inspection activity on the maintenance tag and on the fire protection register</p>	

Note: images are for illustrative purpose only.

File name	Type of document	Fire Extinguisher Model	Date	Rel.	Check	Rev.	Pag.
22031-1_Technical manual	Use and Maintenance technical manual	22031-1	15/01/2024	M.R		0	7/8

22031-1 : Portable Fire Extinguisher, 3 L Foam

5.4) Twenty-year control

End-of-life fire extinguishers must be disposed in accordance with local waste management rules. Before disposal or disassembly, the fire extinguisher MUST BE DEPRESSURIZED by a competent person. Fire extinguishers should always be disposed of through an approved disposal company and in accordance with applicable local and national codes.

* If the fire extinguisher is located in particular environments, the "life time" timing can be reduced (see table 2 at point 5.4).

6) SPARE PARTS LIST AND MAINTENANCE TOOLS

6.1) Spare parts list

For the spare parts list see the table 1 at pag 3.
For more details see web site www.emme-italia.com

6.2) Inspection/Maintenance Tools

For a complete list of recommended tools see web site www.emme-italia.com.
It is recommended to use instruments with controlled calibration and periodically verified (at least every 12 months) with certified sample instrument.

File name	Type of document	Fire Extinguisher Model	Date	Rele.	Check	Rev.	Pag.
22031-1_Technical manual	Use and Maintenance technical manual	22031-1	15/01/2024	M.R		0	8/8