

Use and Maintenance Technical Manual



www.emme-italia.com

Via del Molino, 40 - 52010 Corsalone (AR) - Italy - info@emme-italia.com - Tel. +39.0575.511320
 Other branches Emme Antincendio s.r.l. in Italy : Milano - Padova - Roma - P.IVA/ C.F. 11208251006 - R.E.A. AR-159122

18508-4 - Piemonte 18214 : Wheeled Fire Extinguisher, 50 Kg ABC Powder



- **CYLINDER**
In high-strength alloy steel, external powder painting Red Ral 3000.
- **EXTINGUISHING AGENT**
ABC Powder - MAP 40 %.
- **PROPELLANT**
Dehumidified air or nitrogen (N₂).
- **VALVE**
2"-F , brass body, lever with red painting Ral 3000.
- **USE**
A B C fire rating (solid materials, flammable liquids, flammable gas).
- **BRACKET**
Chassis on wheels, welded at the cylinder, red painting Ral 3000.

Note: image is for illustrative purpose only, the product purchased can has some difference

50 Kg powder wheeled fire extinguisher, temperature range from -30°C to +60°C, manufactured in accordance to **UNI EN 1866-1 (D.M. 6.3.92)**, certified according to the directive for pressure equipment PED 2014/68/EU. Quality Product certification guaranteed by Bureau Veritas Italia. Suitable for use on fire involving electrical voltages up to 1'000 V, at a distance of 1 mt.

APPROVED/CERTIFIED FIRE EXTINGUISHER:



For certified MED 2014/90/EU version:
cod. 16508

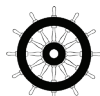

FIRE RATING :



© REPRODUCTION IS PROHIBITED

File name	Type of document	Fire Extinguisher Model	Date	Rele.	Check	Rev.	Pag.
18508-4_ technical manual	Use and Maintenance technical manual	18508-4	07/09/2023	M.R		1	1/8

TECHNICAL SPECIFICATIONS

FIRE RATING	A IV B C
EXTINGUISHING AGENT	ABC Powder - MAP 40 % EPB 0351 (QFIRE 40 - Quimica 21, S.L.)
PROPELLANT	Dehumidified air or Nitrogen (N ₂), 15 bar at 20°C
TEMPERATURE RANGE	-30°C / +60°C
NOMINAL CHARGE	50 Kg
FULL WEIGHT	~ 79 Kg
DIMENSIONS	Height 1100 +/-10 mm ; Width 490 +/-10 mm Depth 560 +/-10 mm
DISCHARGE TIME	~ 39 seconds
VALVE TIGHTENING TORQUE	Minimum 60 Nm, Maximum 70 Nm
CYLINDER PRESSURE TEST	PT 30 bar
CYLINDER VOLUME	62 L.
SAFETY DEVICE	Set between 21 and 26 bar
CYLINDER MATERIAL	Alloy steel
EXTERNAL TREATMENT	Sandblast and powder painting, Red Ral 3000 colour

PACKAGING

(Note: the packaging quantities and measurements are indicative and can be subject at changes)

STANDARD

Maximum nr. 6 pieces for pallet
Pallet dimensions 100x120x135(h) cm

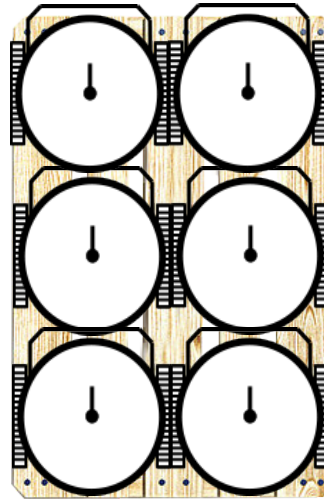

TRANSPORT DISPOSAL

Land transport : Exemption for the purposes of ADR disposal 594

Ship Transport : IMDG Code - UN 1044 class 2.2 Fire Extinguishers

File name	Type of document	Fire Extinguisher Model	Date	Rele.	Check	Rev.	Pag.
18508-4_ technical manual	Use and Maintenance technical manual	18508-4	07/09/2023	M.R		1	2/8

COMPONENTS AND SPARE PARTS LIST

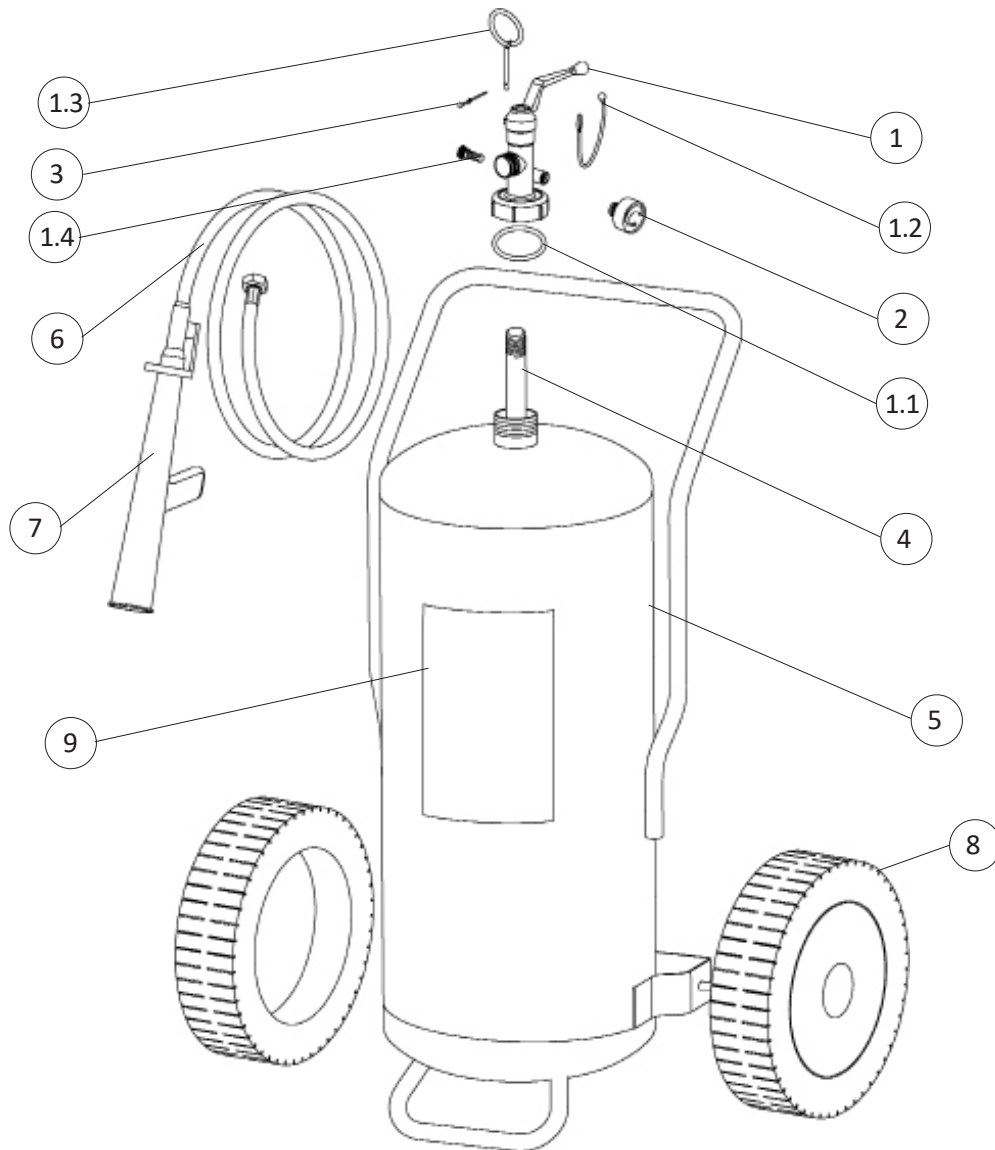

Table 1

NUM.	DESCRIPTION	CODE	NUM.	DESCRIPTION	CODE
1	Valve type lever, 2''-F	0214R	5	Cylinder	18309
1.1	O-ring valve	0203	6	Hose	18421
1.2	Rubber link (red)	0286	7	Dispensing nozzle (complete of ball valve with control lever)	2181
1.3	Safety pin	0283R	8	Wheel + stopwheel (diam. 300mm)	0124
1.4	Safety device	0263R	9	Label 18508-4	18359
2	Pressure gauge	0271-1		Label 16508	18359M
3	Safety pin seal (green)	0285			
4	PVC dip tube	0162			

The spare part at number 1 includes already all others components indicated from 1.1 to 1.4

File name	Type of document	Fire Extinguisher Model	Date	Rele.	Check	Rev.	Pag.
18508-4_ technical manual	Use and Maintenance technical manual	18508-4	07/09/2023	M.R		0	3/8

Maintenance periods for efficiency guarantee, methods and subjects accredited for maintenance

1) GENERAL REQUIREMENTS

All Fire Fighting Fire Extinguishers produced by Emme Antincendio must be installed, inspected and maintained in accordance with the following manual and with the rules in force in the country of destination.

All fire extinguishers must be recharged after partial use with original spare parts.

Every ordinary / extraordinary maintenance operation must be carried out using original spare parts and compliant with the declared certified prototype. The described below maintenance operations must be carried out by recognized personnel qualified by the company Emme Antincendio.

Fire extinguishers are classified into two categories that provide for specific construction standards:

- portable fire extinguishers: fire extinguishers designed to be transported and operated by hand, with a mass not exceeding 20 kg under operating conditions. Reference standard: EN 3-7
- wheeled fire extinguishers: wheel fire extinguishers designed to be transported and operated by hand, with a mass greater than 20 kg. Reference standards: EN 1866-1

Moreover, in relation to the extinguishing agent contained in them, they are identified in:

- water based fire extinguishers including foam extinguishers;
- powder fire extinguishers;
- carbon dioxide fire extinguishers;
- clean agent extinguishers

2) REFERENCE RULES

Fire Extinguishers produced by Emme Antincendio are manufactured in compliance with the following rules:

- EN 3-7: 2008 Portable fire extinguishers;
- EN 1866-1: 2008 Wheeled fire extinguishers;
- PED Directive 2014/68/EU pressure equipment;
- MED Directive 2014/90/EU devices for marine use (only for products bearing the relative MED certification mark, see pag 1 of this document)

3) INSTALLATION

- 1) Position the fire extinguisher in spacious areas, without obstacles.
- 2) Do not expose the fire extinguisher to the atmospheric agent or chemical agent.
(In this case protect the fire extinguisher with suitable cover)
- 3) Do not expose the fire extinguisher to the direct sunlight.
- 4) Verify that the gauge pressure indicator is inside the green area.
- 5) Keep children away from fire extinguisher.
- 6) For Marine equipment or outdoor installation we recommend use of cover.

4) MODALITY AND PRECAUTIONS FOR THE USE

- 1) Follow the operating Instructions printed on the main fire extinguisher label :

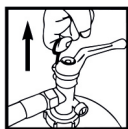

- 1) UNWIND THE HOSE
- 2) REMOVE SAFETY PIN

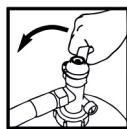

- 3) OPEN THE VALVE

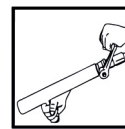

- 4) HOLD THE HOSE, MOVE THE LEVER AND AIM THE JET AT BASE OF FIRE

File name	Type of document	Fire Extinguisher Model	Date	Rel.	Check	Rev.	Pag.
18508-4_ technical manual	Use and Maintenance technical manual	18508-4	07/09/2023	M.R		0	4/8

18508-4 - Piemonte 18214 : Wheeled Fire Extinguisher, 50 Kg ABC Powder

- 2) Do not through the fire extinguisher on to the fire.
- 3) This fire extinguisher is a pressurized vessel and must not be pierced, dented or subjected to external damage.
- 4) Do not direct the extinguishing agent at another person.

5) STEPS AND FREQUENCY RELATED TO MAINTENANCE OPERATIONS (For stored pressure fire extinguishers)

Note: The user have to complies to the national or international rules, if they are more restrictive of the below table

Table 2

Ref.	Periodicity	Step	Operations
5.1	12 Months	Inspection	Check internal pressure using an independent tool.
5.2	5 Years	Maintenance	Check the fluidity of extinguishing agent. Check the dispensing valve and if a not compliance is detected replace it
5.3	10 Years	Hydrotest tank	Check the state of conservation and carry out the hydraulic test of the tank with special machinery. Is raccomended the replacement of dispensing valve
5.4	*20 Years		Is recommended the replacement of the fire extinguisher.

* If the extinguisher is installed in particularly unfavorable environments, the recommended time can be reduced.
(a reduction to 10 years is advisable)

N.B. : All the operations must be calculated from the date of placing on the market.
For the hydraulic test refer to the date stamped on the tank.

5.1) Inspection steps

1	Check the stability and the correct wheel handling.
2	Check the internal pressure with an appropriate independent tool.
3	Check the safety seal and the safety pin conditions.
4	Remove the hose and check the correct internal passage with compressed air.
5	Record the inspection activity on the maintenance tag and on the fire protection register.

5.2) Maintenance steps

1	Check the stability and the correct wheel handling. Check the marking label and replace it if necessary.
2	Discharge the fire extinguisher from the extinguishing agent.
3	Screw off and remove the dispensing valve. Check the fluidity of extinguishing powder, that agglomerates are not present in the cylinder (if powder is suitable, can be reused for recharge the fire extinguisher)
4	Check internally the cylinder and make sure that no signs of corrosion are present. For the hose, check the internal passage with compressed air.
5	Recharge the fire extinguisher with extinguishing agent.
6	Check the dispensing valve and if it is found not compliance replace it with a new one. Screw the valve back on with a tightening torque: minimum 60 Nm - maximum 70 Nm
7	Pressurize the extinguisher (15 bar at 20 °C) with dehumidified air or nitrogen and check if there are leaks.
8	Reinsert the safety pin and relative seal, screw the dispensing hose back on.
9	Record the activity on the maintenance tag and on the maintenance register.

© REPRODUCTION IS PROHIBITED

File name	Type of document	Fire Extinguisher Model	Date	Rele.	Check	Rev.	Pag.
18508-4_ technical manual	Use and Maintenance technical manual	18508-4	07/09/2023	M.R		0	5/8

5.3) Hydraulic test step

At least every 10 years from the production date the fire extinguisher must be overhauled by a hydraulic pressure test in accordance with the pressure values "PT" stamped on the cylinder.

1	Check the stability and the correct wheel handling. Check the marking label and replace it if necessary.
2	Discharge the fire extinguisher from the extinguishing agent.
3	Screw off and remove the dispensing valve. Check the fluidity of extinguishing powder, that agglomerates are not present in the cylinder (if powder is suitable, can be reused for recharge the fire extinguisher)
4	Check internally the cylinder and make sure that no signs of corrosion are present. For the hose, check the internal passage with compressed air.
5	Hydraulic test of the cylinder with suitable tool: maintain hydraulic pressure at "PT" for 30 seconds and proceed with depressurization. Check that the cylinder does not show any deformation, breakage or stability anomalies
6	Proceed with the cylinder drying with suitable tool
7	Recharge the fire extinguisher with extinguishing agent.
8	Is recommended the replacement of dispensing valve. Screw the valve back on with a tightening torque: minimum 60 Nm - maximum 70 Nm
9	Pressurize the extinguisher (15 bar at 20 °C) with dehumidified air or nitrogen and check if there are leaks.
10	Reinsert the safety pin and relative seal, screw the dispensing hose back on.
11	Record the activity on the maintenance tag and on the maintenance register.

File name	Type of document	Fire Extinguisher Model	Date	Rele.	Check	Rev.	Pag.
18508-4_ technical manual	Use and Maintenance technical manual	18508-4	07/09/2023	M.R		0	6/8

Executive details Inspection steps, Maintenance, Hydraulic test

<p>1 - Check: stability and correct wheel handling, cleaning and general conditions. Check the marking label and replace it if damaged.</p>	<p>2 - Discharge completely the extinguisher from the extinguishing agent with appropriate collecting instruments .</p>
<p>3 - Screw off and remove the valve. Check the fluidity of extinguishing powder. If necessary, replace with new powder</p>	<p>4 - Check the inside of the tank with the appropriate inspection lamp. Also check that the dispensing hose and nozzle is not obstructed, checking the correct passage of compressed air inside it, if necessary replace it with a new one. Replace the o-ring, clean and grease the parts.</p>
<p>5 - Hydraulic cylinder test: maintain hydraulic pressure at "PT" for 30 seconds and proceed with depressurization.</p>	<p>6 - Proceed with cylinder drying.</p>
<p>7 - Recharge the fire extinguisher with checked or new extinguishing agent.</p>	<p>8 - Reinstall the dip tube and dispensing valve. Perform the operation with suitable torque wrench, making sure you have set the correct tightening torque.</p>
<p>9 - Pressurize the extinguisher, check that there are no pressure losses, using the appropriate leak detector. Reinstall the safety pin and relative seal.</p>	<p>10 - Screw the dispensing hose back on. Check the correct reading of the pressure gauge</p>
	<p>11 - Record the activity on the maintenance tag and on the maintenance register.</p>

File name	Type of document	Fire Extinguisher Model	Date	Rele.	Check	Rev.	Pag.
18508-4_ technical manual	Use and Maintenance technical manual	18508-4	07/09/2023	M.R		0	7/8

5.4) Twenty-year control

End-of-life fire extinguishers must be disposed in accordance with local waste management rules. Before disposal or disassembly, the fire extinguisher MUST BE DEPRESSURIZED by a competent person. Fire extinguishers should always be disposed of through an approved disposal company and in accordance with applicable local and national codes.

* If the fire extinguisher is located in particular environments, the "life time" timing can be reduced (see table 2 at point 5.4).

6) SPARE PARTS LIST AND MAINTENANCE TOOLS

6.1) Spare parts list

For the spare parts list see the table 1 at pag 3.
For more details see web site www.emme-italia.com

6.2) Inspection/Maintenance Tools

For a complete list of recommended tools see web site www.emme-italia.com.
It is recommended to use instruments with controlled calibration and periodically verified (at least every 12 months) with certified sample instrument.

File name	Type of document	Fire Extinguisher Model	Date	Rele.	Check	Rev.	Pag.
18508-4_ technical manual	Use and Maintenance technical manual	18508-4	07/09/2023	M.R		0	8/8